

Translation from the original manual: IO-800088-PL-20240719



I 0 - 8 0 0 0 8 8 - E N - 2 0 2 4 0 8 2 2

Publication date: 2024.08.22



Po prostu niezawodnie

## USER'S MANUAL



Filtering unit  
**HARD-2000-S**

**EN**



The user manual applies to the following device models:

Catalogue no.	Name of device
<b>800088</b>	<b>HARD-2000-S</b>

User's manual – title: „Filtering unit HARD-2000-S”



*Manufacturer's name and address:*

**KLIMAWENT S.A.** Poland  
Chwaszczyńska 194 street, 81-571 Gdynia  
tel.: +48 58 629 64 80  
fax: +48 58 629 64 19  
e-mail: [klimawent@klimawent.com.pl](mailto:klimawent@klimawent.com.pl)  
WWW: [www.klimawent.com.pl](http://www.klimawent.com.pl)

Copyright © by **KLIMAWENT S.A.**  
Gdynia 2024.08.22

Publication date: 2024.08.22  
*Number of pages: 36*

# CONTENTS

<b>1.</b>	<b>INTRODUCTORY REMARKS .....</b>	<b>5</b>
<b>2.</b>	<b>APPLICATION .....</b>	<b>7</b>
<b>3.</b>	<b>SAFETY OF USE.....</b>	<b>9</b>
	3.1 MANUFACTURER'S DISCLAIMER .....	9
	3.2 SAFETY RULES AND APPLICATION RESTRICTIONS .....	9
<b>4.</b>	<b>TECHNICAL DATA .....</b>	<b>13</b>
<b>5.</b>	<b>STRUCTURE AND OPERATION.....</b>	<b>15</b>
<b>6.</b>	<b>INSTALLATION AND COMMISSIONING .....</b>	<b>17</b>
	6.1 EQUIPMENT .....	17
	6.2 COMMISSIONING.....	18
	6.3 CONTROL PANEL .....	18
<b>7.</b>	<b>OPERATIONAL USE .....</b>	<b>21</b>
	7.1 POWER ON .....	22
	7.2 STARTING THE FAN.....	22
	7.3 STOPPING THE FAN .....	22
	7.4 POWER OFF .....	22
	7.5 EMERGENCY STOP OF THE DEVICE .....	22
	7.6 ALARM SIGNALS.....	23
	7.7 RETURN TO NORMAL OPERATION AFTER THE PROBLEM HAS BEEN REMOVED .....	23
	7.8 UNPLANNED STOPPING AND RESTARTING .....	23
	7.9 REPLACING FILTERS.....	24
	7.10 REPLACEMENT PARTS.....	26
	7.11 ADDITIONAL EQUIPMENT .....	28
	7.12 PERSONAL PROTECTIVE EQUIPMENT.....	29
<b>8.</b>	<b>WORK DISRUPTIONS, CAUSES, REMEDIES .....</b>	<b>31</b>
<b>9.</b>	<b>MAINTENANCE INSTRUCTIONS .....</b>	<b>33</b>
	9.1 GENERAL GUIDELINES .....	33
	9.2 MAINTENANCE WORK SCHEDULE.....	33
<b>10.</b>	<b>HEALTH AND SAFETY INSTRUCTIONS .....</b>	<b>34</b>
<b>11.</b>	<b>TRANSPORT AND STORAGE .....</b>	<b>34</b>
<b>12.</b>	<b>WARRANTY CONDITIONS .....</b>	<b>34</b>
<b>13.</b>	<b>DECLARATION OF CONFORMITY TEMPLATE.....</b>	<b>35</b>





## 1. INTRODUCTORY REMARKS

This manual is intended for the purchaser and future user of the **HARD-2000-S** filtration and ventilation device. Its purpose is to provide the user with guidelines regarding the application, installation, commissioning, and operation of the aforementioned products.

**ATTENTION:** Before proceeding with the installation of the device at the workstation and its start-up, it is essential to thoroughly read the contents of the manual.

**ATTENTION:** Due to the continuous improvement of our products, we reserve the right to make design changes that enhance the utility and safety features of the device.

The design of the **HARD-2000-S** filtration and ventilation device complies with the requirements of the current level of technology and the safety and health provisions contained in the following:

**Directive 2006/42/EC** of the European Parliament and of the Council of 17 May 2006 on machinery, amending Directive 95/16/EC (recast) (OJ L 157, 09.06.2006, p. 24).

Regulation of the Minister of Economy of 21 October 2008 on the requirements for machinery (OJ No. 199 of 2008, item 1228).

**Directive 2014/35/EU** of the European Parliament and of the Council of 26 February 2014 on the harmonization of the laws of the Member States relating to the making available on the market of electrical equipment designed for use within certain voltage limits (OJ L 96, 29.03.2014).

**Directive 2009/125/EC (ErP)** of the European Parliament and of the Council of 21 October 2009 establishing a framework for the setting of ecodesign requirements for energy-related products (OJ L 285, 31.10.2009).

Commission Regulation (EU) No 327/2011 of 30 March 2011 implementing Directive 2009/125/EC of the European Parliament and the Council concerning ecodesign requirements for fans driven by motors with an electric input power between 125 W and 500 kW (OJ L 90, 06.04.2011).

It meets the requirements of the following harmonized standards:

**PN-EN ISO 12100:2012 [EN ISO 12100:2010]** – Safety of machinery – General principles for design – Risk assessment and risk reduction

**PN-EN 60204-1:2018-12 [EN 60204-1:2018]** – Safety of machinery – Electrical equipment of machines – Part 1: General requirements

**PN-EN ISO 13857:2020-03 [EN ISO 13857:2019]** – Safety of machinery – Safety distances to prevent hazard zones from being reached by upper and lower limbs

**PN-EN 60529:2003+A2:2014-07 [EN 60529:1991+A1:2000+A2:2013]** – Degrees of protection provided by enclosures (IP Code)

**PN-EN IEC 61439-1:2021-10 [EN IEC 61439-1:2021]** – Low-voltage switchgear and controlgear assemblies – Part 1: General rules





## 2. APPLICATION

The **HARD-2000-S** filtration device is designed for air purification from dust and gas pollutants, with dust particles that can be either dry or sticky in nature. It is an ideal solution for, among others, the filtration of:



- aerosols generated during spray painting of small surfaces,
- air contaminated with dust and gases produced during laser cutting of rubber, plywood, plexiglass, acrylic, and other plastics, as well as during grinding of these materials,
- dust and gas pollutants generated during the polishing of various materials,
- oily welding fumes accompanied by gases emitted during welding,
- air contaminated with grease particles from kitchen exhausts,
- unpleasant odours in chemical laboratories,
- fumes generated during upholstery work, including cutting and glueing.











### 3. SAFETY OF USE

#### 3.1 MANUFACTURER'S DISCLAIMER

! ATTENTION	
	KLIMAWENT S.A. conducted a risk analysis solely for the <b>HARD-2000-S</b> device, but it does not take into account the additional risks that may arise from the use and application of the device in ways not intended by the manufacturer at the installation site.
	It is <b>FORBIDDEN</b> to make any unauthorized modifications to the device or install additional elements that are not part of the device or are additional equipment and may affect the safety of using the device!
	The manufacturer, <b>KLIMAWENT S.A.</b> , declares the product's conformity with the directives and harmonized standards based on the conducted conformity assessment process. The manufacturer issues a declaration of conformity, which applies solely to the machine in the condition in which it was placed on the market and does not cover any components other than those approved by the manufacturer, which may have been added by the end-user or any subsequent actions carried out by them.

#### 3.2 SAFETY RULES AND APPLICATION RESTRICTIONS

! ATTENTION	
	<b>READ</b> this manual before operating the device! Keep it for future reference in a place accessible to all users.
	<b>PROTECT</b> the device from mechanical damage.
	<b>PROTECT</b> all markings, descriptions, nameplates and especially warnings from being erased, damaged beyond recognition or removed.
	The device is intended for <b>PROFESSIONAL</b> use. Before starting work, familiarize yourself with the procedures and operating instructions for the device. It may only be operated by <b>TRAINED</b> and <b>QUALIFIED</b> personnel.

! WARNING	
<b>Risk of device damage, injury, or severe bodily harm!</b>	
	The manufacturer is not liable for any bodily injuries resulting from <b>IMPROPER USE</b> . During all operations performed on the device (installation, maintenance, cleaning, etc.), operators must be equipped with appropriate personal protective equipment (PPE) to prevent or minimize injuries that cannot be avoided otherwise.
	Before installing the device, check the load-bearing capacity of the structural elements to which it will be attached or on which it will move. <b>IMPROPER, NEGLIGENT, or UNSTABLE</b> mounting of the device may lead to damage and pose a real <b>THREAT</b> to people nearby.
	The device <b>MUST NOT</b> be operated before ensuring that the continuity and connection of the protective PE conductor have been checked.

**! WARNING**

Risk of device damage, injury, or severe bodily harm!



**UNAUTHORIZED** modifications to the device and the installation of additional components that are not part of the device or its optional equipment are **PROHIBITED!**

**! WARNING**

Risk of device damage or operational disruptions.



The temperature of the conveyed air **MUST NOT** exceed **+60°C**.



The ambient temperature during operation **MUST** be between **-20°C** and **+40°C**; otherwise, at higher temperatures, the fan's electric motor will be exposed to **INSUFFICIENT COOLING**, which could ultimately cause damage.



The relative humidity of the environment **MUST NOT** exceed 95% without condensation. Excessive moisture in the air can damage or adversely affect the electric motor.



The atmospheric pressure **MUST** be within the range of **800 hPa** to **1100 hPa**.



The device **MUST NOT** operate in an environment that may cause an accelerated rate of corrosion.



**DO NOT BLOCK** or **COVER** the air outlet of the device – do not place or position objects on the outlet of the silencer that partially or completely obstructs the device's outlet. This will reduce or completely block the airflow through the device.

**! DANGER**

Risk of device destruction, property damage, injury, or severe bodily harm.



After each change in the device's position, the user **MUST** lock the wheels to prevent the device from rolling off uneven surfaces.



**POSITIONING** the device on a slope greater than 3% is **PROHIBITED!** Failure to comply with this condition may result in the device tipping over while manoeuvring the extraction arm installed on the device. The device is stable when used with a 2, 3, or 4-meter ERGO LUX-L arm, provided the above requirement is met.

**! DANGER**

Risk of severe injury or death due to electric shock!



The device **MUST NOT** be operated before ensuring that the continuity and connection of the protective **PE** conductor have been checked.

**! DANGER****Risk of device damage, fire, or explosion!**

**USING** the device to transport air containing **CORROSIVE** contaminants that could adversely affect the device is **PROHIBITED!**



**USING** the device to purify air containing **CARCINOGENIC, RADIOACTIVE** dust, or air contaminated with **PATHOGENS** and other dangerous substances posing a high risk to human health and life is **PROHIBITED!**



**USING** the device to transport a mixture of air with **FLAMMABLE SUBSTANCES** in the form of gases, vapours, mists, or dust that create an **EXPLOSIVE ATMOSPHERE** with air is **PROHIBITED!**



#### 4. TECHNICAL DATA

Table 1

Type	Maximum capacity [m <sup>3</sup> /h]	Maximum vacuum [Pa]	Motor power [kW]	Supply voltage [V]	Sound pressure level (dB(A))		Mass [kg]
					1 m	5 m	
<b>HARD-2000-S</b>	2000	2000	1,5	230 / 50 Hz	73	66,5	237

#### INFORMATION



The device's flow rate is specified with clean filters. The filtration efficiency is 99.95%.

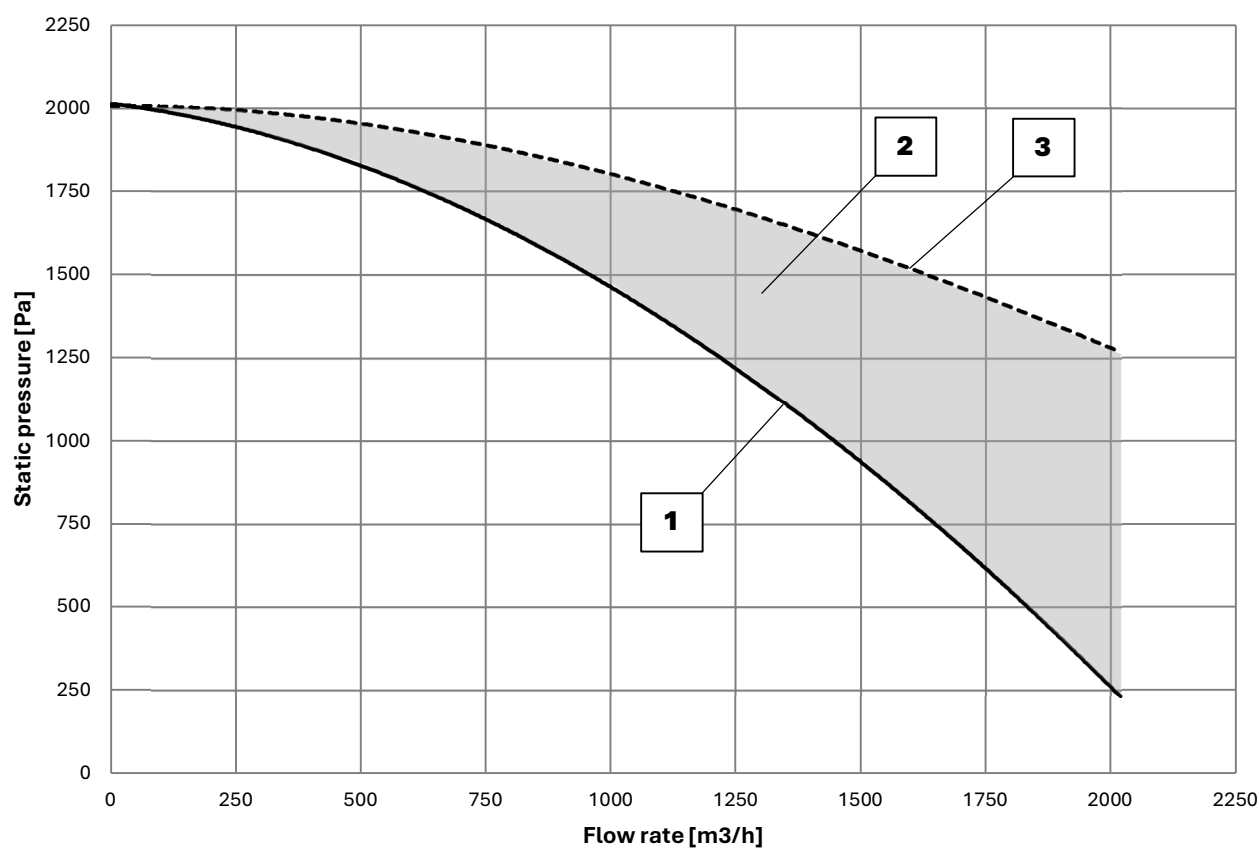

1 – Ciężnienie dyspozycyjne; 2 – Opory wewnętrzne urządzenia; 3 – Spręż wentylatora

Picture 1 Flow characteristic



## 5. STRUCTURE AND OPERATION

Air is drawn in through the suction inlets, flows through the individual filters where it is cleaned, and is then expelled outside.

The **HARD-2000-S** device includes:

- housing made of steel sheets,
- **P1** – centrifugal fan with a housing made of cast aluminium,
- **F1** – "PAINT-STOP" pre-filter, class G3 (flame retardant),
- **F2** – pocket filter, class F8,
- **F3** – high-efficiency filter, class H13,
- **F4** – gas absorber in the form of a cartridge filled with 2 x 10 kg of granulated activated carbon (activated carbon supplied in bulk),
- two pressure switches that trigger a warning light when the pocket and high-efficiency filters experience excessive resistance,
- connectors for mounting extraction arms or flexible ducts,
- **P2** – silencer on the fan outlet,
- operating hours counter,
- electrical unit.

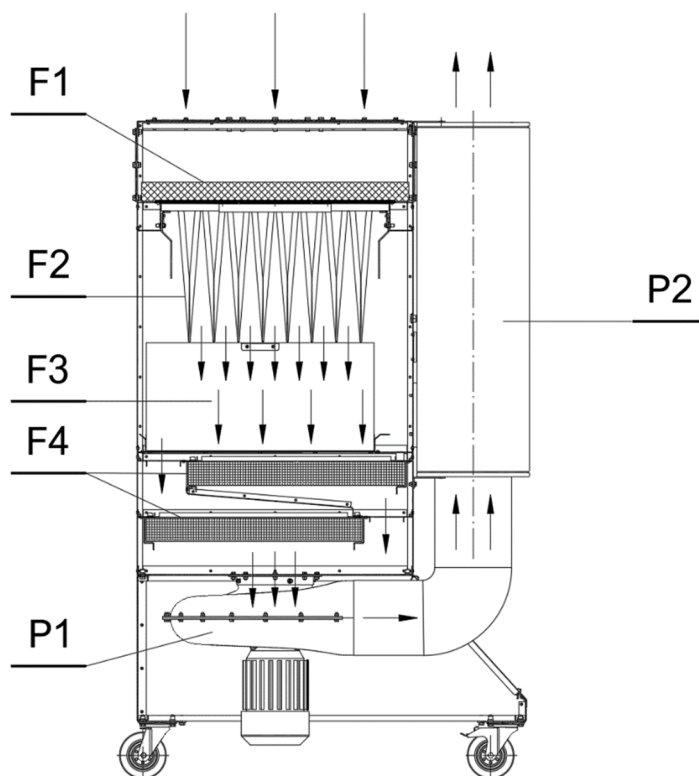

Picture 2 Structure of the device

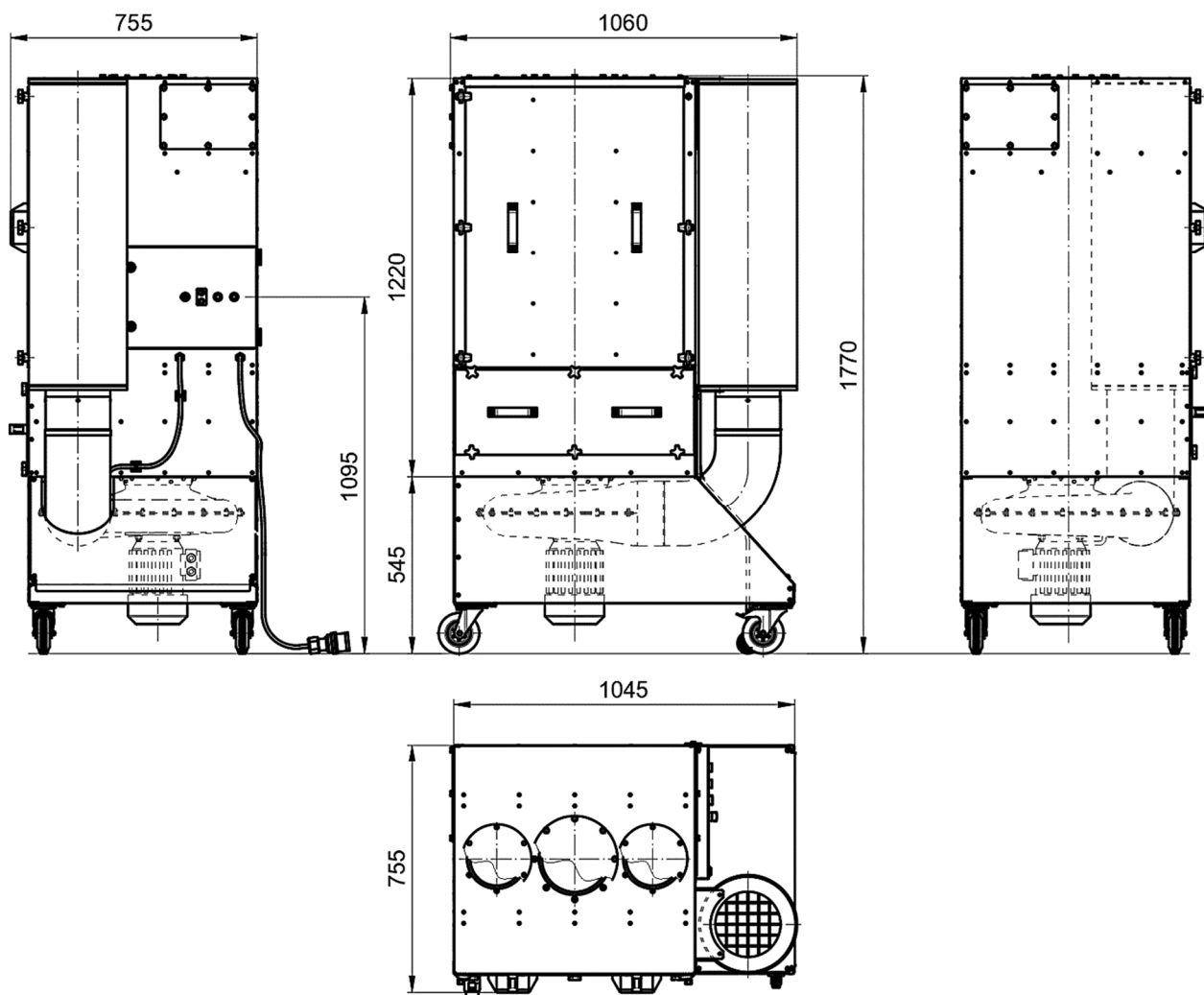

Picture 3 Overall dimensions

## 6. INSTALLATION AND COMMISSIONING

### 6.1 EQUIPMENT

Before use, the **HARD-2000-S** device must be equipped with an **ERGO** suction arm or a flexible duct. To connect the ERGO arms, an appropriate **DB-ERGO** bracket can be used, while for connecting the flexible duct, a suitable **DC-type** connection stub should be used.

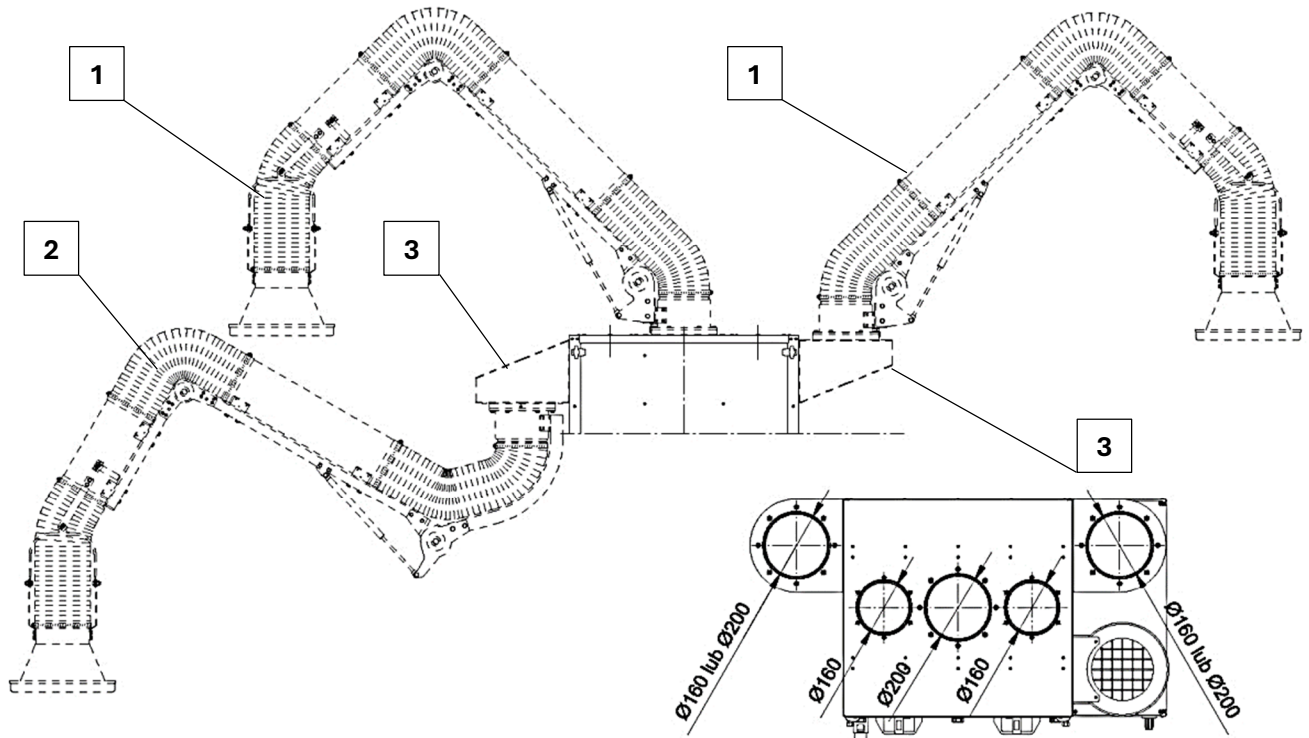

**Picture 4 List of possible additional equipment**

- 1** – ERGO LUX standing extraction arm; **2** – ERGO LUX hanging extraction arm;  
**3** – Side bracket for ERGO LUX extraction arms

The **ERGO LUX-L** or **ERGO LUX-D** arms can be installed directly on the top plate of the device or via the **DB-ERGO LUX-L** or **DB-ERGO LUX-D** bracket.

The **DB-ERGO LUX** brackets can be installed with the suction opening "up" or "down," allowing for the installation of ERGO arms in both hanging and standing versions.

The flexible duct should be connected to the device via the **DC** connection stub.

### INFORMATION



The brackets and ERGO LUX arms are additional equipment for the device – see item 7.11 – ADDITIONAL EQUIPMENT on page 28.



## 6.2 COMMISSIONING

Before the first operation of the device, the following steps should be completed:

1. Remove both covers from the device.
2. Take out the HEPA-FW high-efficiency filter and the FK pocket filter.
3. Unscrew the bolts inside the device that secure the activated carbon cartridges.
4. Remove the activated carbon cartridges.
5. Fill the cartridges with activated carbon up to a few millimetres below the top edge of the cartridge (activated carbon is supplied in a 25 kg factory bag). Spread the carbon evenly and compact it gently (densify the filling). Pay special attention to ensuring the carbon is evenly distributed along the side walls of the cartridges.
6. Slide the cartridges back into the device, being careful not to damage the seals or shift the carbon, which could create empty spaces.
7. Screw the bolts back in to secure the activated carbon cartridges.
8. Reinsert the HEPA-FW high-efficiency filter and the FK pocket filter.
9. Close the covers. The device is now ready for operation.

## 6.3 CONTROL PANEL

Functions of the electrical unit:

**Q1M** – Motor switch – protects the motor from damage due to blocked start-up, overload, and short circuits.

**P1** – Operating hours counter – indicates the number of operating hours of the device.

**F1** – Overcurrent protection – protects the control circuit.

**K1M** – Relay – controls the operation of the frequency converter.

**B1** – Differential pressure switch – compares the pressure before and after the filter.

**B2** – Differential pressure switch – compares the pressure before and after the filter.

**S1.H2** – White indicator light – signals that voltage is supplied to the control circuit.

**S2.H2** – White indicator light – signals that the device is operating.

**H3** – Yellow indicator light – signals a dirty filter.

**H4** – Yellow indicator light – signals a dirty filter.

**S2.1** – Fan operation – STOP.

**S2.2** – Fan operation – START.

**FAL1** – Frequency converter.

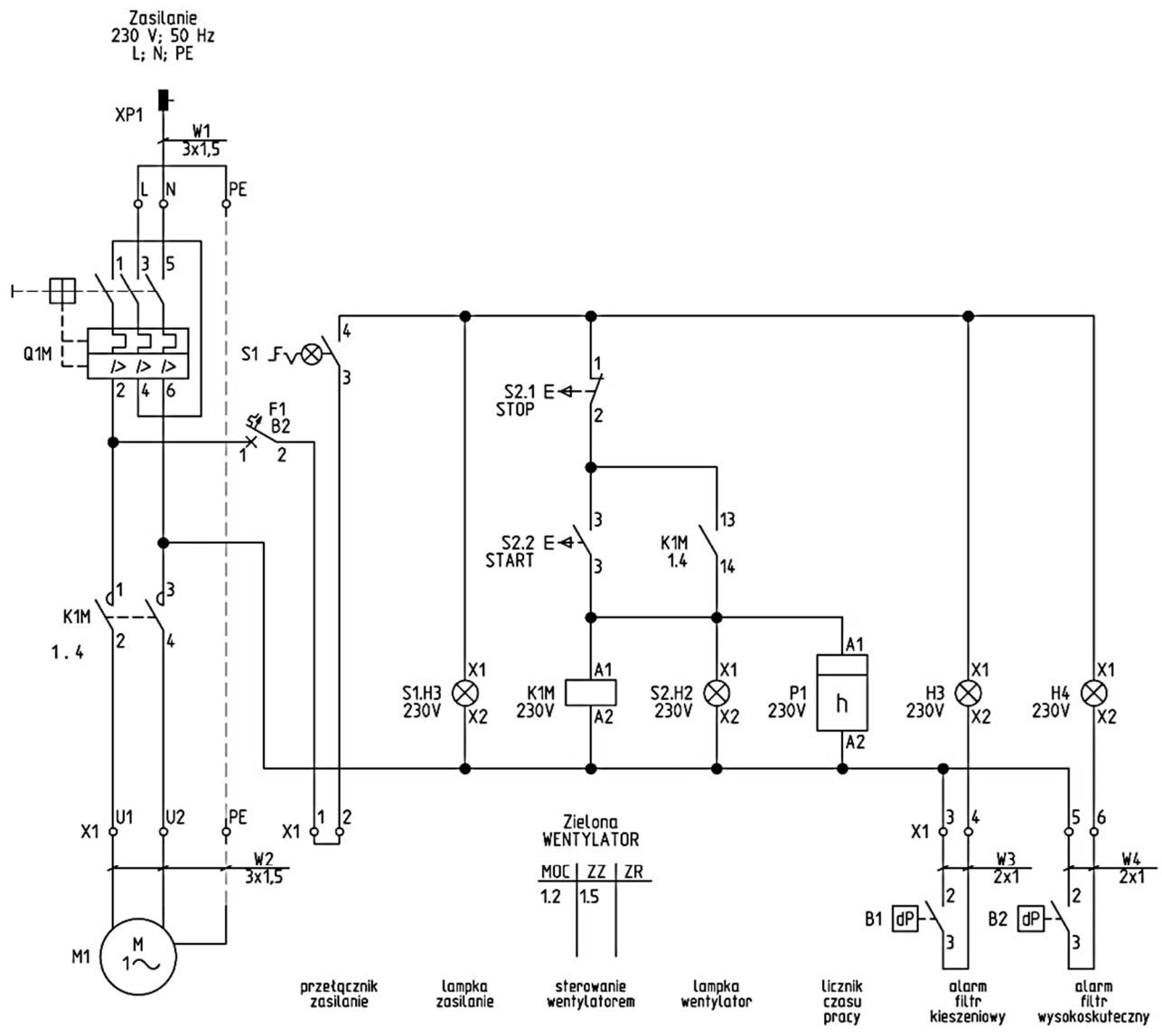

**UWAGI:**

1. Nastawa wyłłącznika silnikowego  $I_t=1,1I_n$
2. Klasa ochronności I
3. stopień ochrony IP 44

**Picture 5 Electrical diagram part 1**

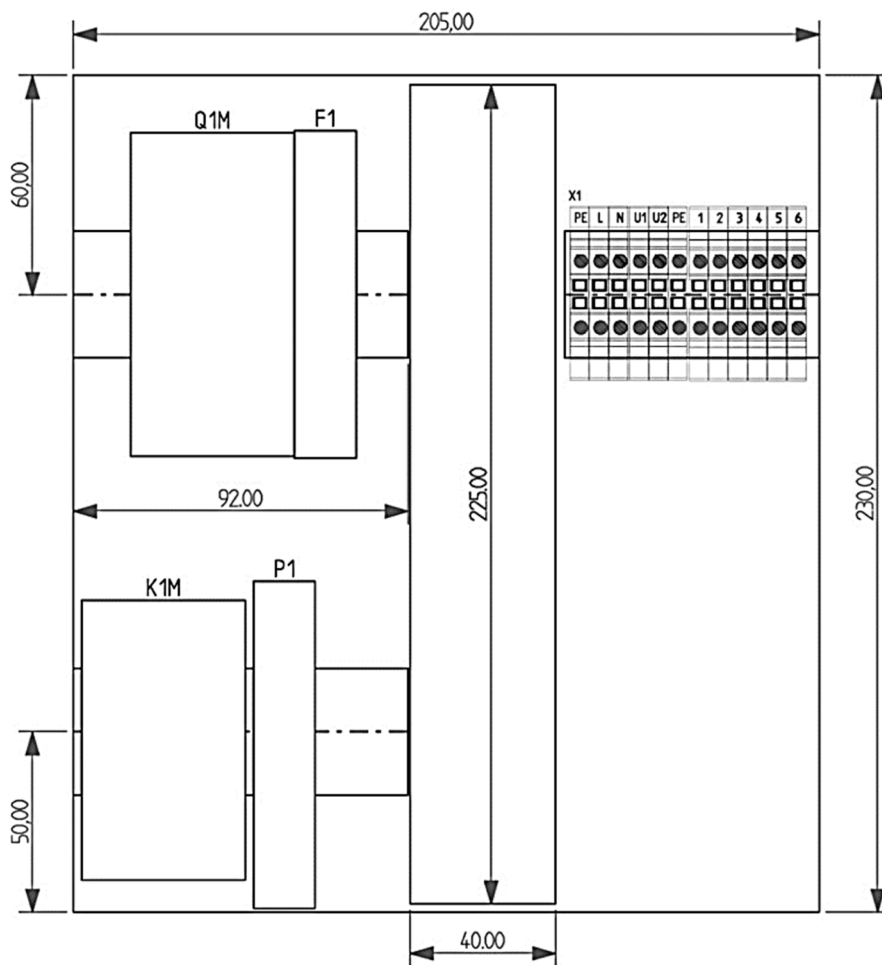

Płyta montażowa

Picture 6 Electrical diagram part 2

## 7. OPERATIONAL USE

During operation, it is important to monitor the indicator lights on the device's control panel. The control panel includes the following signal and control elements:

- illuminated rotary switch **S1** is used to power the device on,
- and illuminated two-button switch **S2.1/S2.2** for stopping and starting the fan,
- warning lights **H3** and **H4**.

The illumination of the warning lights indicates the need to replace the filters:

- the **H3 yellow** light signals the need to replace the pocket filter after the filter's resistance exceeds the threshold value,
- the **H4 yellow** light signals the need to replace the high-efficiency filter after the filter's resistance exceeds the threshold value.

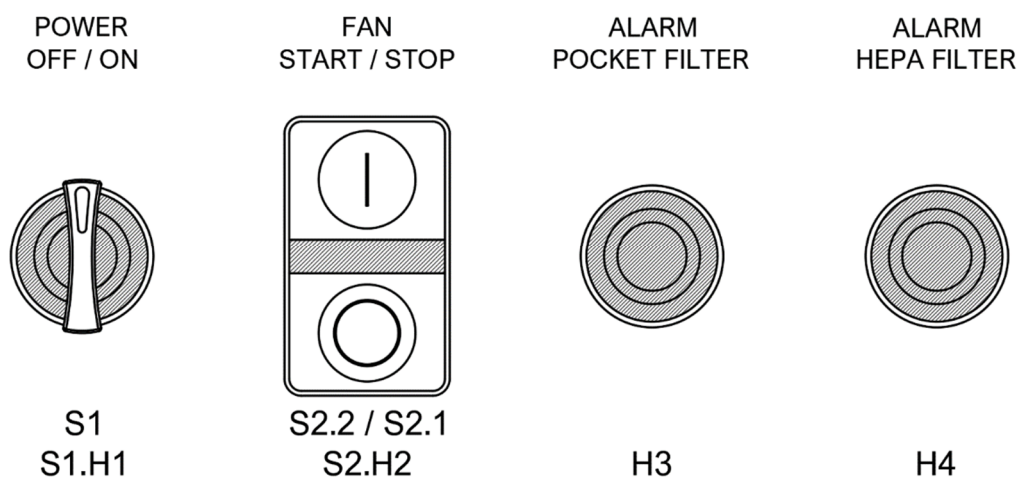

Picture 7 Control panel

**! WARNING****Danger:**

- entrapment of clothing or limbs,
- impact from closing doors due to negative pressure,
- impact from a compressed air pulse,
- impact from exhaust air from the outlet chamber,
- exposure to excessive impulse noise.



Before starting the device, ensure that the inspection doors to the filters and the device covers are closed.



**DO NOT** bring limbs, other body parts, or clothing near the unshielded suction nozzle of the device while the fan is operating. The device functions properly when used in conjunction with an appropriate extraction arm, such as the ERGO LUX.

**7.1 POWER ON**

Turn the **S1** switch knob **to the right** towards the **ON** position. The presence of power in the device's circuit is indicated by the illumination of the **S1.H1** light in the switch.

**7.2 STARTING THE FAN**

After turning on the power with the **S1** knob, press the "upper" button **S2.2 – ON** – the fan will start. The operation of the fan is indicated by the illumination of the middle light in the **S2.1/S2.2** switch.

**7.3 STOPPING THE FAN**

Press the "lower" button **S2.1 – OFF** on the **S2.1/S2.2** switch. The light on the switch will turn off.

**! WARNING**

The fan will stop with a **slow run-down** after power disconnection, due to the inertia of the rotating impeller and the electric motor!

**7.4 POWER OFF**

Turn the **S1** switch knob **to the left** towards the **OFF** position. The disconnection of power to the device's circuit is indicated by the **S1.H1** light in the switch **turning off**.

**7.5 EMERGENCY STOP OF THE DEVICE**

Turn the **S1** knob **to the left** towards the **OFF** position.

**! WARNING**

The fan will stop with a **slow run-down** after power disconnection, due to the inertia of the rotating impeller and the electric motor!

## 7.6 ALARM SIGNALS

### ! CAUTION



Immediately **REACT** to alarm signals displayed on the control panel and take prompt **CORRECTIVE ACTION!**

#### 7.6.1 POWER FAILURE OR ENGINE FAILURE

If there is no power when switching the **S1** switch and the indicator light on **S1** does not illuminate, several potential causes may exist:

- **Power failure** in the electrical supply to the device,
- **Activation of the motor switch Q1M** due to:
  - motor overload,
  - short circuit, or
  - blocked start-up.

The motor switch **Q1M** protects the fan motor from overload, short circuits, and the consequences of a blocked start-up. If **Q1M** is triggered, the control system will be completely disconnected. This issue is not indicated by the illumination of a warning light. When this occurs, you should identify and eliminate the cause of the problem, then check the motor's electrical and mechanical condition.

#### 7.6.2 FILTER FAILURE

In the event of filter contamination exceeding the limit, alarm signals will be given in the form of warning lamps. Lamp **H3** will light up in the event of borderline contamination of the **pocket filter** or lamp **H4** will light up in the event of borderline contamination of the **high-efficiency filter**.

### ! ATTENTION



The device **DOES NOT SIGNAL** the consumption of the coal deposit. The saturation of the activated coal deposit can be recognized by smell when the filtered air begins to change its smell.

#### 7.7 RETURN TO NORMAL OPERATION AFTER THE PROBLEM HAS BEEN REMOVED

Starting the device after it has been stopped due to a failure requires a check of the device's operation - start the device and let it work for at least 15 minutes to stabilize its parameters and make sure that there are no problems and the failure does not return. After this time, the device can be used safely.

#### 7.8 UNPLANNED STOPPING AND RESTARTING

In the event of a power failure, the fan will stop with a free run. In such a situation, before restarting, first, check the condition of the device and whether the electrical devices in the electrical assembly are functional and not damaged.

The device should be started and allowed to work for at least 15 minutes to stabilize its parameters and make sure that there are no problems. After this time, the device can be used safely.



## 7.9 REPLACING FILTERS

### 7.9.1 NON-WOVEN FILTER

The "Paint-Stop" fleece should be replaced after noticing a drop in fan efficiency. This filter is the first filtration stage in the device and it stops the largest part of the impurities sucked in by the device. It is recommended to check the condition of the filter regularly to ensure even efficiency of the device during operation. The "PAINT-STOP" fleece filter is loosely placed on a perforated base in the middle of the device just below the suction opening. When replacing, slide out the fleece and install a new one with the same parameters – see point 7.10 – REPLACEMENT PARTS on page 26.

### 7.9.2 POCKET FILTER

The pocket filter is the second filtration stage in the device. It is suspended under the non-woven filter. When replacing the pocket filter, release the filter clamps slide it out of the guides and insert a new one with the same parameters – see point 7.10 – REPLACEMENT PARTS on page 26.

### 7.9.3 HIGH-EFFICIENCY FILTER

The high-efficiency HEPA filter is the third stage of filtration in the device. It is mounted under the pocket filter. It stands on the partition. The high-efficiency filter has a seal on one side.

When replacing the high-efficiency filter, first remove the pocket filter, then use the handles at the front and back of the filter to lift it and remove it from the device, which will protect the filter from damaging the filter seal and, consequently, from improper operation. This principle should be followed when inserting and removing the filter.

The user should determine the replacement period of this filter for a specific technological process.

#### ! CAUTION



**Pay attention** to the way the high-efficiency filter is mounted – the filter must lie on the side with the glued seal! Only then will the filter contact with the partition be properly sealed and ensure proper filter operation.

### 7.9.4 CARBON FILTER (COAL DEPOSIT)

The activated carbon filter is the last, fourth stage of filtration. The activated carbon should be replaced when it stops absorbing unpleasant odours. The operating time counter should be monitored.

The activated carbon bed should be replaced after approximately 200 hours of operation, but this depends on the intensity of contamination. Considering the mass of the activated carbon in the filter and its absorption capacity, it can be assumed that the coal deposit should be replaced after absorbing approximately 5 kg of gases. To replace the coal deposit, unscrew the screws holding the cassettes in the device and remove them completely, empty them, dispose of the activated carbon, and then refill with new granulate. New activated carbon should be poured into the cassettes in equal amounts and carefully distributed over the entire cassette. Insert into the device and tighten the screws to achieve a tight contact.

**! WEEE**

Some parts or substances included in the **HARD-2000-S** device must be treated following the recommendations of the **European Parliament Directive 2012/19/EU** on waste electrical and electronic equipment (**WEEE**). These are the components of the electrical switchboard, in particular the control panel with a microcontroller and display, but also filters and coal deposit.

Such parts and substances **MUST NOT** be thrown into the waste bin for unsorted waste, but taken to a special point for used electrical and electronic equipment or a point for the disposal of hazardous waste following the law in force in the given territory!

## 7.10 REPLACEMENT PARTS

### 7.10.1 NON-WOVEN FILTER

A filter in the form of a woven fabric with progressively arranged fibres enables effective retention of particles of various sizes.

**Table 2**

Type	Catalogue no.	Mass [kg]	Dimensions [mm]	Class
<b>PS-HARD-2000-S</b>	<b>838F76</b>	0,05	700x740x50	G3

### 7.10.2 POCKET FILTER

Pre-filter in the form of sewn-together bag pockets mounted on a frame enabling the filter to be mounted in the ventilation duct.

**Table 3**

Type	Catalogue no.	Mass [kg]	Dimensions [mm]	Class
<b>FK-HARD-2000-S</b>	<b>838F86</b>	2,3	610x610x360x20	F8

### 7.10.3 HIGH-EFFICIENCY FILTER

A cassette filter with a filter insert provides a very high filtration class. Cassette with one-sided seal in the form of a gasket. When replacing the filter, make sure that the filter is installed so that it lies on the gasket - during operation, the negative pressure caused by the airflow will press the filter against the partition and seal the contact.

#### **! CAUTION**



**Pay attention** to the way the high-efficiency filter is mounted – the filter must lie on the side with the glued seal! Only then will the filter contact with the partition be properly sealed and ensure proper filter operation.

**Table 4**

Type	Catalogue no.	Mass [kg]	Dimensions [mm]	Class
<b>FW-HARD-2000-S</b>	<b>838F83</b>	18,8	610x610x292	H13



#### 7.10.4 GRANULATED ACTIVATED CARBON

The coal deposit in the form of granulate of size 4x8 mm is supplied in bags. Used carbon should be replaced when odours are noticed to be coming through the device.

The cassettes should be filled tightly and evenly with "fresh" granulate and reinstalled in the device.

It is recommended to check the operating time when the bed is replaced to be able to predict the next maintenance.

**Table 5**

Type	Catalogue no.	Mass [kg]	Comments
<b>ORGANOSORB 10CO 4x8</b>	<b>874W04</b>	2 x 10	2 cassettes holding 10 kg of activated carbon each

## 7.11 ADDITIONAL EQUIPMENT

Table 6 Mounting brackets for extraction arms

Type	Catalogue no.	Mass [kg]	Application
<b>DB-ERGO-L</b>	<b>817W28</b>	4,2	Installation of the ERGO LUX-L extraction arm
<b>DB-ERGO-D</b>	<b>817W29</b>	4,0	Installation of the ERGO LUX-D extraction arm

Table 7 Duct connections

Type	Catalogue no.	Application
<b>DC-160</b>	<b>830Z14</b>	Installation of the Ø160 mm suction hose
<b>DC-200</b>	<b>830Z15</b>	Installation of the Ø200 mm suction hose

Table 8 ERGO LUX extraction arms in hanging version

Type	Catalogue no.	Connection diameter [mm]
<b>ERGO LUX-L/2</b>	<b>810R74</b>	Ø160
<b>ERGO LUX-L/3</b>	<b>810R75</b>	
<b>ERGO LUX-L/4</b>	<b>810R76</b>	
<b>ERGO LUX-D/2</b>	<b>810R77</b>	Ø200
<b>ERGO LUX-D/3</b>	<b>810R78</b>	
<b>ERGO LUX-D/4</b>	<b>810R79</b>	

Table 9 ERGO LUX extraction arms in a standing version

Type	Catalogue no.	Connection diameter [mm]
<b>ERGO LUX-L/2-R</b>	<b>810R84</b>	Ø160
<b>ERGO LUX-L/3-R</b>	<b>810R85</b>	
<b>ERGO LUX-L/4-R</b>	<b>810R86</b>	
<b>ERGO LUX-D/2-R</b>	<b>810R87</b>	Ø200
<b>ERGO LUX-D/3-R</b>	<b>810R88</b>	
<b>ERGO LUX-D/4-R</b>	<b>810R89</b>	

### INFORMATION



To obtain a full offer of arms suitable for the **HARD-2000-S** device, please contact the manufacturer **KLIMAWENT S.A.**



## 7.12 PERSONAL PROTECTIVE EQUIPMENT

During operation, maintenance, cleaning, i.e. use, cleaning the device from deposits, cleaning the interior and other maintenance activities, always use personal protective equipment:

### RECOMMENDED PERSONAL PROTECTIVE EQUIPMENT



#### Dust mask required

Warning indicates that personnel must wear protective equipment.

Protective equipment must always be worn during operation and maintenance.



#### The requirement to disconnect the device from the power supply

A warning indicates the requirement to disconnect the device from the mains when carrying out maintenance, fault finding and similar activities that require opening covers and access to hazardous components, especially the fan impeller.







## 8. WORK DISRUPTIONS, CAUSES, REMEDIES

Table 10

DISTURBANCES	POSSIBLE CAUSES	COUNTERMEASURES
Reduced device performance when no alarms are signaled	<b>PAINT STOP</b> fleece is excessively contaminated	Replace the <b>PAINT STOP</b> fleece with a new one
	Clogged device inlet	Locate the foreign body and remove it. Clean the suction lines. Uncover the outlet of the device.
The device's performance drops while the <b>H3 alarm</b> is being signalled.	Excessively dirty <b>pocket filter</b>	Replace the <b>pocket filter</b> with a new one
The device's performance drops while the <b>H4 alarm</b> is signalled.	Excessively dirty <b>HEPA high-efficiency filter</b>	Replace the <b>high-efficiency HEPA filter</b> with a new one
Emission of unpleasant odours	Spent coal deposit	Replace the carbon deposit in both cartridges
The appearance of tremors and vibrations	Fan impeller or motor damage	Check the vibrations on the fan and replace the impeller or motor with a new one
After switching on the <b>S1 switch</b> , the device does not start	<b>Q1M</b> protection tripped	Check the status of the <b>Q1M</b> switch
After pressing the <b>S2.2 button</b> the fan does not start	Fan start blocked	Check the inside of the fan. Remove foreign body.





## 9. MAINTENANCE INSTRUCTIONS

### 9.1 GENERAL GUIDELINES

#### ! CAUTION



**DISCONNECT** the device from the electrical supply, **TURN OFF** the control, and **WAIT** until all mechanisms have stopped. **SECURE** the control against uncontrolled start-up!



**USE** personal protective equipment, protective clothing and work footwear! **FOLLOW** safety rules.

#### ! ATTENTION



The **USER** is responsible for the maintenance of the device and its parts. Regular maintenance is a condition for safe use and fulfilment of the **WARRANTY CONDITIONS**.



All repairs **MUST BE PERFORMED BY THE MANUFACTURER** or its **REPRESENTATIVE**. In special cases, this can be performed by the **USER**, but in this case, contact the manufacturer **KLIMAWENT S.A.**

### 9.2 MAINTENANCE WORK SCHEDULE

Tabela 11

PERIOD	ACTION
Current control and activities	Clean the device and its components regularly to avoid excessive build-up of dirt inside and out.
Once every 3-6 months	Perform a visual inspection of the supporting structure and housing, as well as the condition of the screw connections and the tightness of the closure of the inspection covers.
Once every 12-18 months	Check the condition of the electrical connections and the condition of the fan.
	Check the continuity of the protective connection and the connection of the device to the main grounding busbar.
	Check the condition of the inside of the filter chambers. Check if dirt is getting through to the "clean" side of the device to the fan. Remove any accumulated deposits.
Once every 18-24 months	Check the condition of the electric motor.
	Replace the filters with new ones or when the filters are worn out.



## 10. HEALTH AND SAFETY INSTRUCTIONS

### ATTENTION:

- Start-up and operation may only be performed after reading this manual.
- The socket circuits should have short-circuit protection and differential protection (see electrical diagram).
- All repairs should be performed after the fan has stopped and the device has been disconnected from the mains.

## 11. TRANSPORT AND STORAGE

The **HARD-2000-S** filter ventilation device is transported on a pallet, protected with foil from atmospheric influences. During transport, the device must be placed in a vertical position, secured against movement or tipping over. The device should be stored in dry and airy rooms.

## 12. WARRANTY CONDITIONS

The warranty period is specified in the device's warranty card. The warranty does not cover:

- mechanical damage to the device caused by the user,
- damage resulting from use contrary to its intended purpose or failure to follow this user manual,
- damage resulting from improper transport, storage or improper maintenance.

Failure to comply with the **MANUFACTURER'S DISCLAIMER** section of this manual, and in particular, unauthorized modification of the device or use of it contrary to its intended purpose, will void the warranty.



## 13. DECLARATION OF CONFORMITY TEMPLATE

**DEKLARACJA ZGODNOŚCI WE UE**  
**EC&EU DECLARATION OF CONFORMITY**1. **Producent / Manufacturer:** KLIMAWENT S.A. 81-571 Gdynia, ul. Chwaszczyńska 194, Polska2. **Opis produktu / Product name:** Urządzenie filtracyjne  
*Filter unit*3. **Model / Model:**

HARD-1000-S	HARD-2000-S	HARD-5000-S
800092	800088	800093

4. **Nr produktu / Product number:**5. **Nr seryjny / Serial number:** XXXX6. **Rok produkcji / Year of production:** RRRR7. **Niniejsza deklaracja zgodności wydana zostaje na wyłączną odpowiedzialność producenta.**  
*This declaration of conformity is issued under the sole responsibility of the manufacturer.*8. **Wymieniony powyżej wyrób spełnia wymagania następujących dyrektyw europejskich:**  
*The product mentioned above meets the requirements of the following European directives:*

MD 2006/42/WE	2006/42/EC
LVD 2014/35/UE	2014/35/EU
ERP 2009/125/WE	2009/125/EC

9. **Odniesienia do norm zharmonizowanych oraz norm krajowych (lub ich fragmentów), które zastosowano, w stosunku do których deklarowana jest zgodność:**  
*References to the harmonized standards and the national standards (or parts thereof) that have been applied and against which conformity is declared:*

PN-EN ISO 12100:2012	EN ISO 12100:2010
PN-EN ISO 13857:2020-03	EN ISO 13857:2019
PN-EN 60204-1:2018-12	EN 60204-1:2018
PN-EN 60529:2003+A2:2014-07	EN 60529:1991+A1:2000+A2:2013
PN-EN IEC 61439-1:2021-10	EN IEC 61439-1:2021

10. **Osoba upoważniona do przechowywania i przygotowania dokumentacji technicznej:** Teodor Świrbutowicz,  
*A person authorized to store and prepare technical documentation:* KLIMAWENT S.A.11. **Niniejsza deklaracja zgodności jest podstawą do oznakowania wyrobu znakiem:**  
*This declaration of conformity is the basis for marking the product with the mark:*

Deklaracja zgodności wystawiona została w oparciu o przeprowadzony proces oceny zgodności. Deklaracja ta odnosi się wyłącznie do maszyny w stanie, w jakim została wprowadzona do obrotu i nie obejmuje części składowych dodanych przez użytkownika końcowego lub przeprowadzonych przez niego późniejszych działań.

The declaration of conformity was issued based on the conformity assessment process. This declaration relates only to the machine in the state in which it was placed on the market and does not cover components added by the end user or subsequent actions performed by the end user.

Gdynia, 2021-03-29

W imieniu producenta podpisali / **Signed on behalf of the manufacturer by:**

Michał Kulczyński

  
CZŁONEK ZARZĄDU /  
MEMBER OF THE BOARD

Joanna Koniarek

  
PREZES ZARZĄDU /  
CEO

User's manual – title: „Filtering unit HARD-2000-S”



I 0 - 8 0 0 0 8 8 - E N - 2 0 2 4 0 8 2 2



**KLIMAWENT**

Po prostu niezawodnie

**KLIMAWENT S.A. Poland**

Chwaszczyńska 194 street, 81-571 Gdynia

tel.: +48 58 629 64 80

fax: +48 58 629 64 19

e-mail: [klimawent@klimawent.com.pl](mailto:klimawent@klimawent.com.pl)

WWW: [www.klimawent.com.pl](http://www.klimawent.com.pl)

[klimawent@klimawent.com.pl](mailto:klimawent@klimawent.com.pl)

Copyright © by **KLIMAWENT S.A.**

Gdynia 2024.08.22